

## NPG12-40Ah 12V40Ah

### Valve Regulated Lead Acid Battery



#### Specifications

Nominal voltage	12V (6 cells per unit)	
Rated capacity (10HR)	40Ah/10.8V	
Dimensions	Length	197±2mm (7.76inch)
	Width	165±2mm (6.50inch)
	Height	170±2mm (6.69inch)
	Total height	170±2mm (6.69inch)
Approx. weight	13.50kg (29.80lbs)±3%	

#### Outer dimensions (mm)

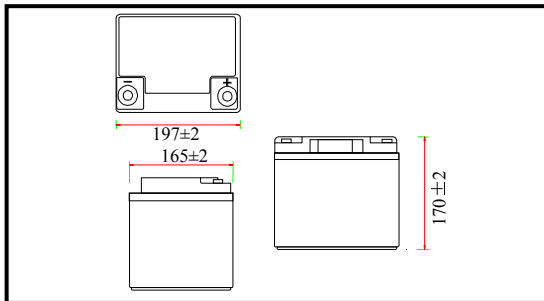

#### Terminal type (mm)

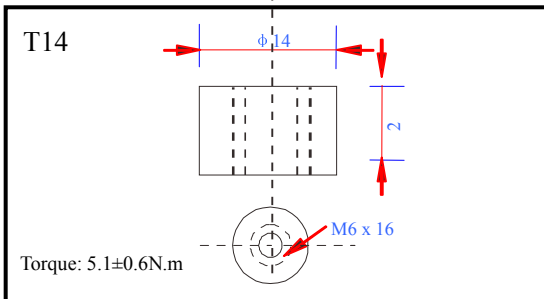

#### Characteristics

Capacity (25°C)	10HR (10.8V)	40Ah
	3HR (10.8V)	30Ah
	1HR (10.5V)	22Ah
Terminal type		T14
Internal resistance (Fully charged, 25°C)		Approx. 8.5mΩ
Capacity affected by temperature (10HR)	40°C	102%
	25°C	100%
	0°C	85%
	-15°C	65%
Self-discharge (25°C)	3 months	Remaining capacity: 91%
	6 months	Remaining capacity: 82%
	12 months	Remaining capacity: 65%
Nominal operating temperature		25°C±3°C (77°F±5°F)
Operating temperature range	Discharge	-15°C~50°C (5°F~122°F)
	Charge	-10°C~50°C (14°F~122°F)
	Storage	-20°C~50°C (-4°F~122°F)
Float charging voltage (25°C)		13.50 to 13.80V Temperature compensation: -18mV/°C/Block
Cyclic charging voltage (25°C)		14.50 to 14.70V Temperature compensation: -30mV/°C/Block
Maximum charging current		12A
Maximum discharge current		400A (5 sec.)
Design life	12 years for floating (25°C)	
	Eurobat (20°C): 10-12 years, long life.	

#### Construction

Component	Positive plate	Negative plate	Container	Cover	Separator	Electrolyte	Safety valve	Terminal
Raw material	Lead dioxide	Lead	ABS	ABS	AGM	Gel	Rubber	Copper

#### Constant current discharge characteristics unit: Ampere/Block (at 25°C, 77°F)

F.V/Time	10min	15min	30min	60min	2h	3h	4h	5h	8h	10h	20h
9.60V	78.0	64.0	38.8	24.0	14.6	10.4	8.16	6.94	4.90	4.07	2.16
9.90V	75.7	62.5	38.0	23.6	14.5	10.3	8.11	6.90	4.87	4.06	2.15
10.2V	72.5	60.2	36.9	23.0	14.4	10.3	8.06	6.85	4.83	4.05	2.15
10.5V	69.4	58.1	36.0	22.3	14.2	10.2	8.00	6.80	4.8	4.03	2.13
10.8V	65.5	55.0	34.6	21.6	13.8	10.0	7.76	6.60	4.66	4.00	2.12

#### Constant power discharge characteristics unit: Watt/Block (at 25°C, 77°F)

F.V/Time	10min	15min	30min	60min	2h	3h	4h	5h	8h	10h	20h
9.60V	842	703	435	274	169	122	96.0	82.0	58.2	48.6	25.9
9.90V	817	686	427	269	168	122	95.4	81.5	57.8	48.5	25.8
10.2V	783	661	414	263	167	121	94.7	80.9	57.4	48.4	25.8
10.5V	750	638	404	254	164	120	94.1	80.4	57.0	48.1	25.6
10.8V	708	604	389	246	160	118	91.3	78.0	55.3	47.8	25.4

Note 1: Above characteristics data can be obtained within three charge and discharge cycles.

### ● Discharge characteristics (25°C)

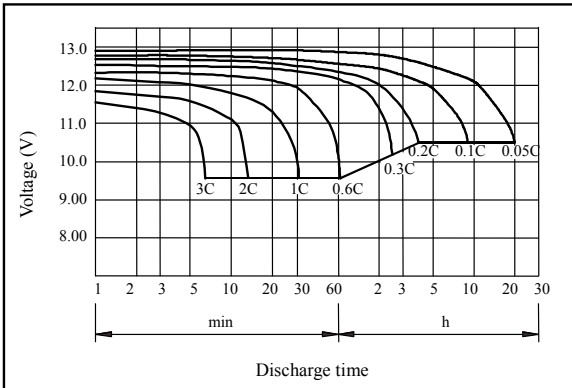

### ● Charging characteristics (25°C)

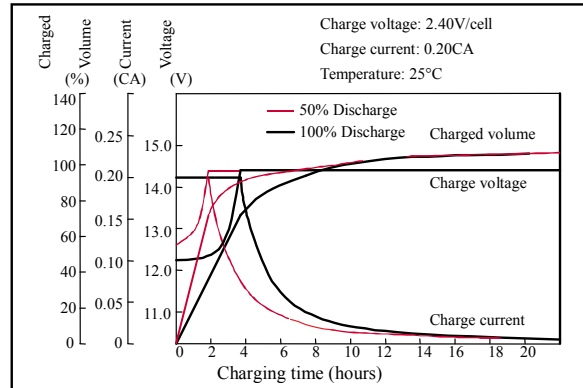

### ● Temperature effects on capacity

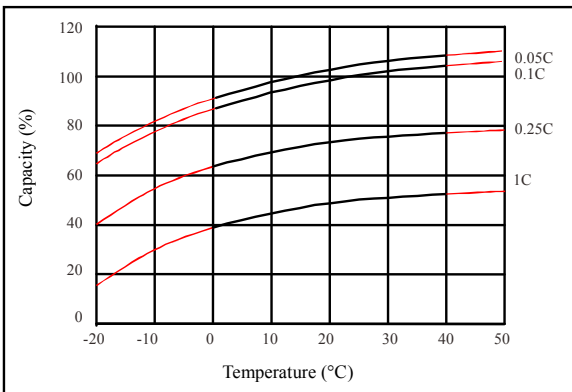

### ● Self-discharge characteristics

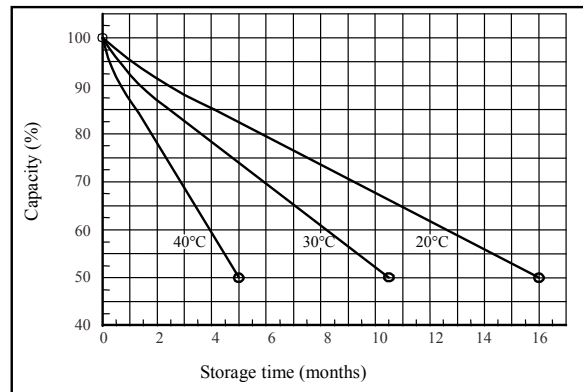

### ● Floating life on temperature

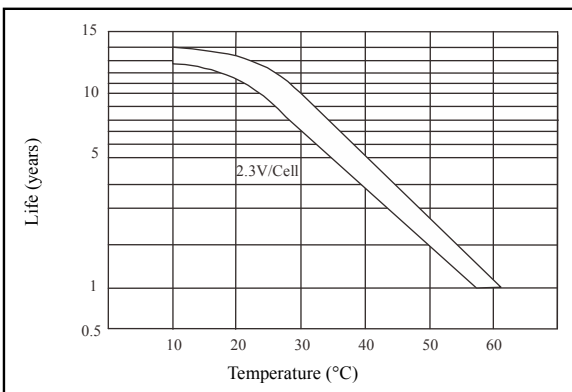

### ● Cycle life on D.O.D (25°C)

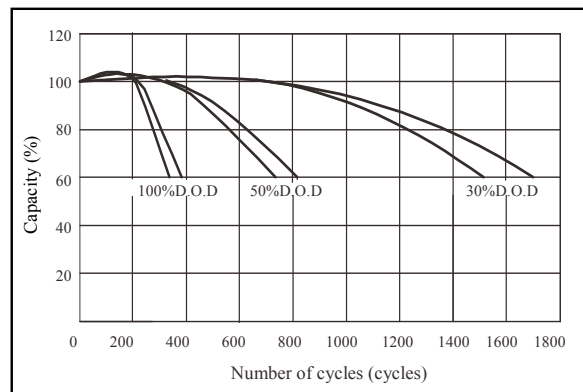

### ● Relationship for OCV and capacity (25°C)

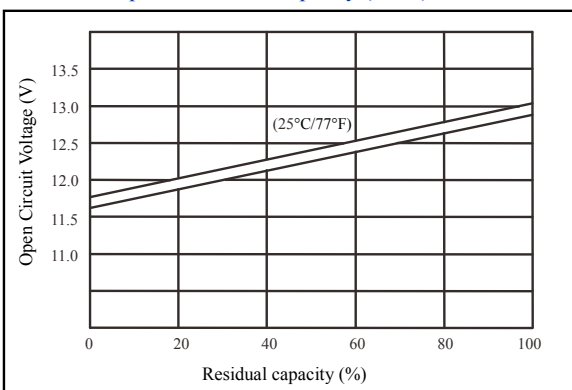

### ● Relationship for charging voltage and temperature

