

NPG12-150Ah 12V150Ah

Valve Regulated Lead Acid Battery



Specifications

Nominal voltage	12V (6 cells per unit)	
Rated capacity (10HR)	150Ah/10.8V	
Dimensions	Length	485±2mm (19.09inch)
	Width	172±2mm (6.77inch)
	Height	240±2mm (9.45inch)
	Total height	240±2mm (9.45inch)
Approx. weight	44.50kg (98.10lbs)±3%	

Outer dimensions (mm)

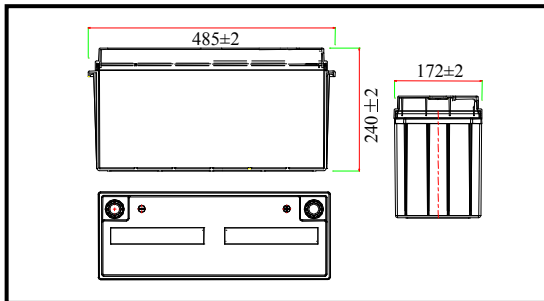

Terminal type (mm)

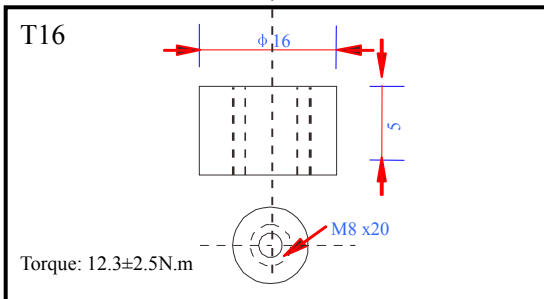

Characteristics

Capacity (25°C)	10HR (10.8V)	150Ah
	3HR (10.8V)	112.5Ah
	1HR (10.5V)	83Ah
Terminal type		T16
Internal resistance (Fully charged, 25°C)		Approx. 3.8mΩ
Capacity affected by temperature (10HR)	40°C	102%
	25°C	100%
	0°C	85%
	-15°C	65%
Self-discharge (25°C)	3 months	Remaining capacity: 91%
	6 months	Remaining capacity: 82%
	12 months	Remaining capacity: 65%
Nominal operating temperature		25°C±3°C (77°F±5°F)
Operating temperature range	Discharge	-15°C~50°C (5°F~122°F)
	Charge	-10°C~50°C (14°F~122°F)
	Storage	-20°C~50°C (-4°F~122°F)
Float charging voltage (25°C)		13.50 to 13.80V Temperature compensation: -18mV/°C/Block
Cyclic charging voltage (25°C)		14.50 to 14.70V Temperature compensation: -30mV/°C/Block
Maximum charging current		30A
Maximum discharge current		1200A (5 sec.)
Design life	12 years for floating (25°C)	
	Eurobat (20°C): 10-12 years, long life.	

Construction

Component	Positive plate	Negative plate	Container	Cover	Separator	Electrolyte	Safety valve	Terminal
Raw material	Lead dioxide	Lead	ABS	ABS	AGM	Gel	Rubber	Copper

Constant current discharge characteristics unit: Ampere/Block (at 25°C, 77°F)

F.V/Time	10min	15min	30min	60min	2h	3h	4h	5h	8h	10h	20h
9.60V	293	240	146	90.0	54.8	39.0	30.6	26.0	18.4	15.3	8.09
9.90V	284	234	143	88.7	54.5	38.8	30.4	25.9	18.3	15.2	8.08
10.2V	272	226	138	86.4	54.0	38.5	30.2	25.7	18.1	15.2	8.05
10.5V	260	218	135	83.7	53.2	38.3	30.0	25.5	18.0	15.1	8.01
10.8V	246	206	130	81.0	51.8	37.5	29.1	24.7	17.5	15.0	7.95

Constant power discharge characteristics unit: Watt/Block (at 25°C, 77°F)

F.V/Time	10min	15min	30min	60min	2h	3h	4h	5h	8h	10h	20h
9.60V	3159	2635	1633	1026	635	459	360	307	218	182	97.1
9.90V	3064	2572	1600	1011	631	456	358	306	217	182	96.9
10.2V	2938	2477	1551	985	625	453	355	304	215	181	96.6
10.5V	2812	2393	1513	954	616	450	353	301	214	180	96.1
10.8V	2654	2266	1458	923	600	441	342	292	207	179	95.4

Note 1: Above characteristics data can be obtained within three charge and discharge cycles.

● Discharge characteristics (25°C)



● Charging characteristics (25°C)

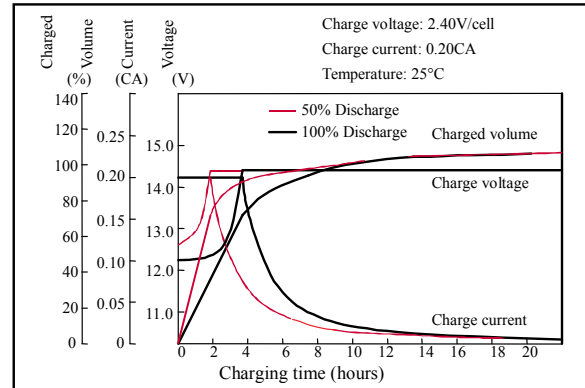

● Temperature effects on capacity

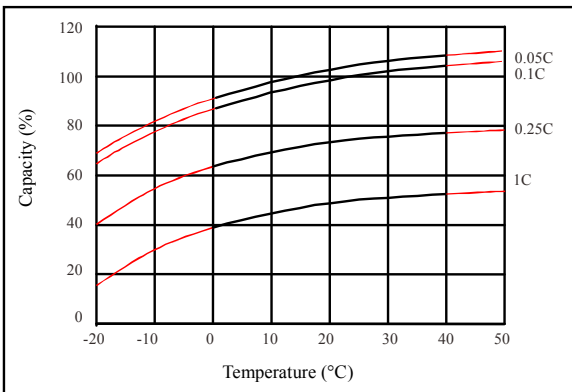

● Self-discharge characteristics

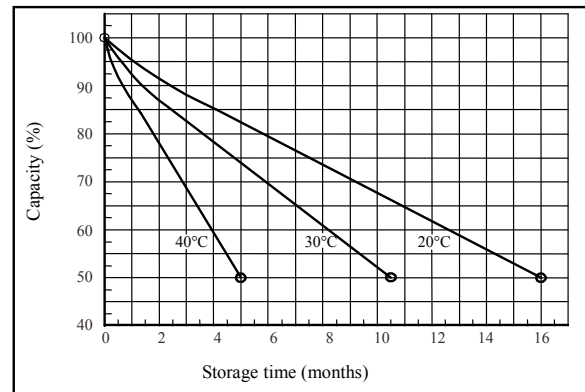

● Floating life on temperature

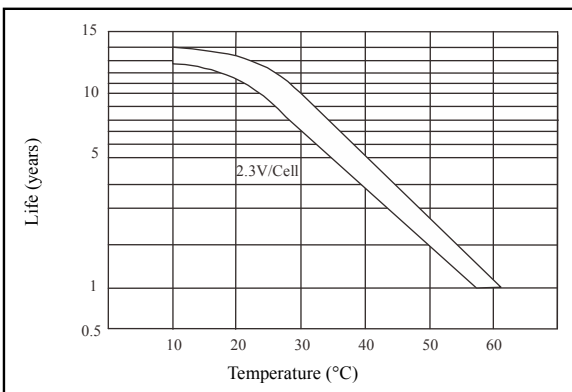

● Cycle life on D.O.D (25°C)

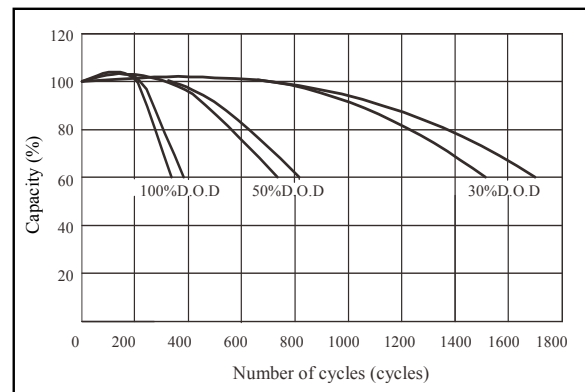

● Relationship for OCV and capacity (25°C)



● Relationship for charging voltage and temperature

