

NP6-180Ah 6V180Ah

Valve Regulated Lead Acid Battery



Specifications

Nominal voltage	6V (3 cells per unit)	
Rated capacity (10HR)	180Ah/5.4V	
Dimensions	Length	306±2mm (12.05inch)
	Width	169±2mm (6.65inch)
	Height	220±2mm (8.66inch)
	Total height	225±2mm (8.86inch)
Approx. weight	27.50kg (60.60lbs)±3%	

Outer dimensions (mm)

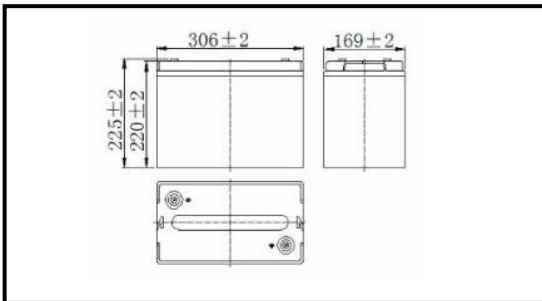

Terminal type (mm)

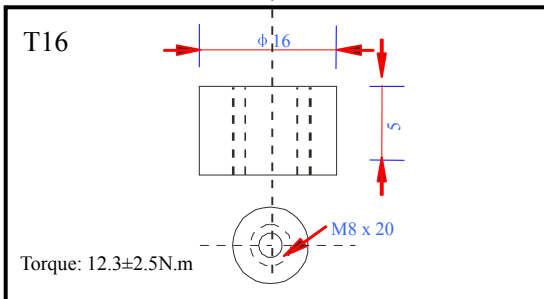

Characteristics

Capacity (25°C)	10HR (5.4V)	180Ah
	3HR (5.4V)	135Ah
	1HR (5.25V)	100Ah
Terminal type		T16
Internal resistance (Fully charged, 25°C)		Approx. 2.2mΩ
Capacity affected by temperature (10HR)	40°C	102%
	25°C	100%
	0°C	85%
	-15°C	65%
Self-discharge (25°C)	3 months	Remaining capacity: 91%
	6 months	Remaining capacity: 82%
	12 months	Remaining capacity: 65%
Nominal operating temperature		25°C±3°C (77°F±5°F)
Operating temperature range	Discharge	-15°C~50°C (5°F~122°F)
	Charge	-10°C~50°C (14°F~122°F)
	Storage	-20°C~50°C (-4°F~122°F)
Float charging voltage (25°C)		6.75 to 6.90V Temperature compensation: -9mV/°C/Block
Cyclic charging voltage (25°C)		7.25 to 7.50V Temperature compensation: -15mV/°C/Block
Maximum charging current		54A
Maximum discharge current		1250A (5 sec.)
Design life	10 years for floating (25°C)	
	Eurobat (20°C): 10-12 years, long life.	

Construction

Component	Positive plate	Negative plate	Container	Cover	Separator	Electrolyte	Safety valve	Terminal
Raw material	Lead dioxide	Lead	ABS	ABS	AGM	Sulfuric acid	Rubber	Copper

Constant current discharge characteristics unit: Ampere/Block (at 25°C, 77°F)

F.V/Time	10min	15min	30min	60min	2h	3h	4h	5h	8h	10h	20h
4.80V	392	302	181	111	65.8	47.4	37.8	32.3	22.2	18.3	9.71
4.95V	381	295	177	110	65.4	47.1	37.6	32.1	22.1	18.3	9.69
5.10V	365	284	172	107	64.8	46.8	37.3	31.9	21.9	18.2	9.66
5.25V	349	275	168	103	63.8	46.4	37.1	31.7	21.8	18.1	9.61
5.40V	330	260	162	100	62.2	45.0	36.0	30.7	21.1	18.0	9.54

Constant power discharge characteristics unit: Watt/Block (at 25°C, 77°F)

F.V/Time	10min	15min	30min	60min	2h	3h	4h	5h	8h	10h	20h
4.80V	2119	1660	1015	634	381	279	222	191	132	109	58.3
4.95V	2055	1620	995	625	379	277	221	190	131	109	58.2
5.10V	1971	1561	964	609	375	275	220	189	130	109	58.0
5.25V	1886	1507	941	590	370	273	218	187	129	108	57.6
5.40V	1780	1428	906	571	360	265	211	182	125	107	57.2

Note 1: Above characteristics data can be obtained within three charge and discharge cycles.

● Discharge characteristics (25°C)

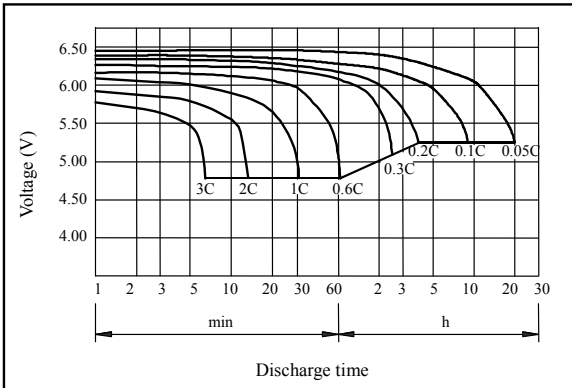

● Charging characteristics (25°C)

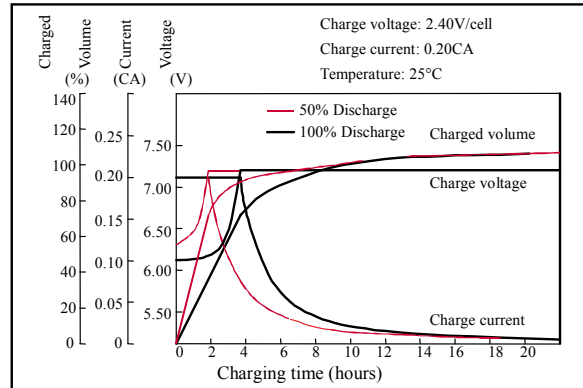

● Temperature effects on capacity

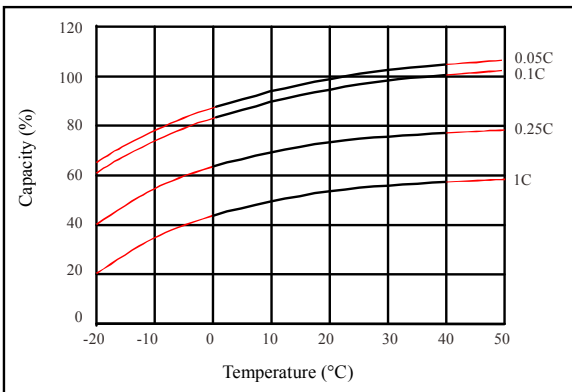

● Self-discharge characteristics



● Floating life on temperature

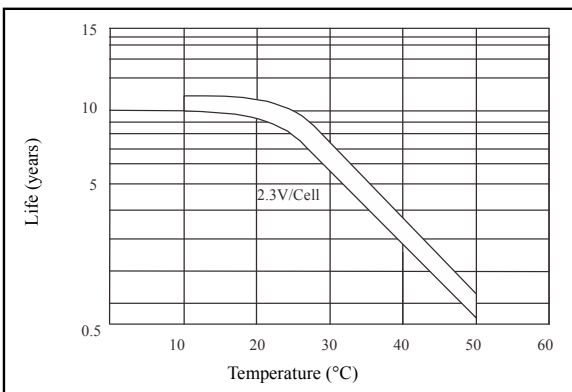

● Cycle life on D.O.D (25°C)

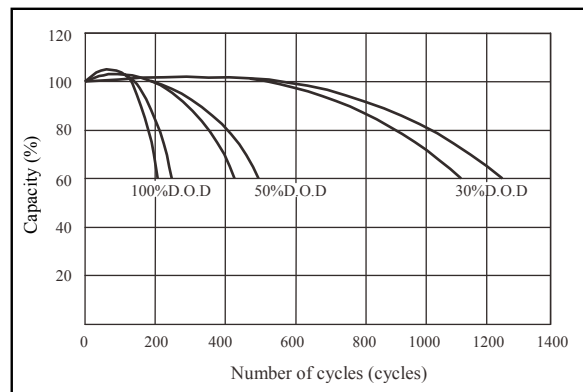

● Relationship for OCV and capacity (25°C)

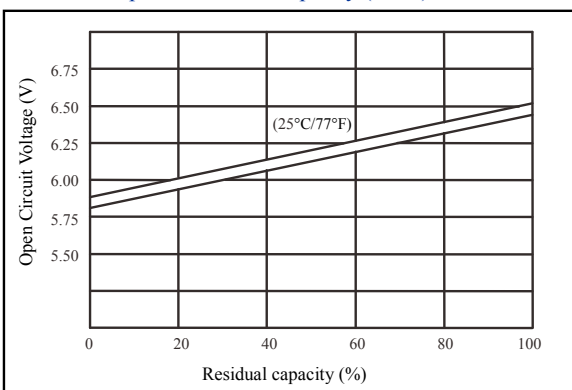

● Relationship for charging voltage and temperature

