

NP12-55Ah 12V55Ah

Valve Regulated Lead Acid Battery



Specifications

Nominal voltage	12V (6 cells per unit)	
Rated capacity (10HR)	55Ah/10.8V	
Dimensions	Length	230±2mm (9.06inch)
	Width	138±2mm (5.43inch)
	Height	211±2mm (8.31inch)
	Total height	215±2mm (8.46inch)
Approx. weight	17.30kg (38.10lbs)±3%	

Outer dimensions (mm)

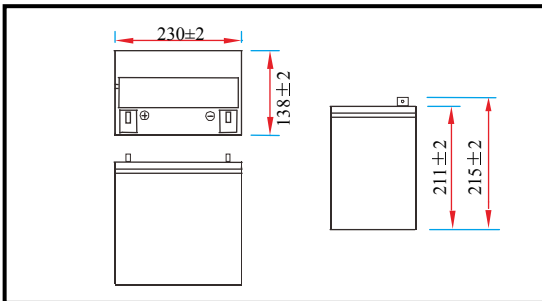

Terminal type (mm)

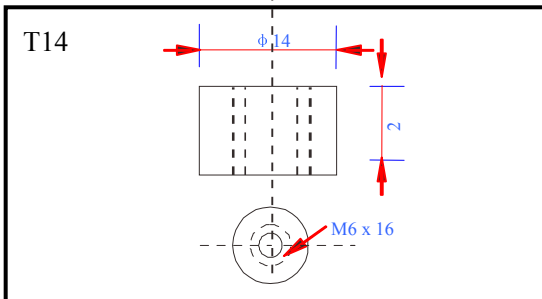

Characteristics

Capacity (25°C)	10HR (10.8V)	55Ah
	3HR (10.8V)	41.1Ah
	1HR (10.5V)	30.5Ah
Terminal type		T14
Internal resistance (Fully charged, 25°C)		Approx. 6.5mΩ
Capacity affected by temperature (10HR)	40°C	102%
	25°C	100%
	0°C	85%
	-15°C	65%
Self-discharge (25°C)	3 months	Remaining capacity: 91%
	6 months	Remaining capacity: 82%
	12 months	Remaining capacity: 65%
Nominal operating temperature		25°C±3°C (77°F±5°F)
Operating temperature range	Discharge	-15°C~50°C (5°F~122°F)
	Charge	-10°C~50°C (14°F~122°F)
	Storage	-20°C~50°C (-4°F~122°F)
Float charging voltage (25°C)		13.50 to 13.80V Temperature compensation: -18mV/°C/Block
Cyclic charging voltage (25°C)		14.50 to 15.00V Temperature compensation: -30mV/°C/Block
Maximum charging current		16.5A
Maximum discharge current		550A (5 sec.)
Design life	10 years for floating (25°C)	
	Eurobat (20°C):10-12 years, long life.	

Construction

Component	Positive plate	Negative plate	Container	Cover	Separator	Electrolyte	Safety valve	Terminal
Raw material	Lead dioxide	Lead	ABS	ABS	AGM	Sulfuric acid	Rubber	Copper

Constant current discharge characteristics unit: Ampere/Block (at 25°C, 77°F)

F.V/Time	10min	15min	30min	60min	2h	3h	4h	5h	8h	10h	20h
9.60V	120	92.4	55.3	34.0	20.1	14.5	11.6	9.87	6.79	5.60	2.97
9.90V	116	90.2	54.2	33.5	20.0	14.4	11.5	9.82	6.75	5.59	2.96
10.2V	112	86.9	52.5	32.6	19.8	14.3	11.4	9.75	6.70	5.57	2.95
10.5V	107	83.9	51.2	31.6	19.5	14.2	11.3	9.68	6.66	5.54	2.94
10.8V	101	79.5	49.4	30.6	19.0	13.8	11.0	9.39	6.46	5.50	2.92

Constant power discharge characteristics unit: Watt/Block (at 25°C, 77°F)

F.V/Time	10min	15min	30min	60min	2h	3h	4h	5h	8h	10h	20h
9.60V	1295	1015	620	387	233	170	136	117	80.6	66.9	35.6
9.90V	1256	990	608	382	231	169	135	116	80.2	66.7	35.5
10.2V	1204	954	589	372	229	168	134	115	79.6	66.5	35.4
10.5V	1152	921	575	360	226	167	133	114	79.1	66.1	35.2
10.8V	1088	873	554	349	220	162	129	111	76.7	65.7	35.0

Note 1: Above characteristics data can be obtained within three charge and discharge cycles.

● Discharge characteristics (25°C)

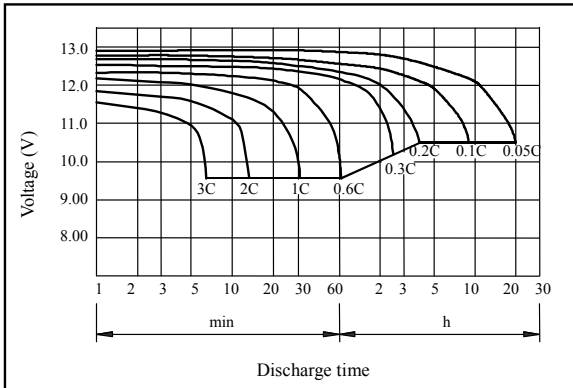

● Charging characteristics (25°C)

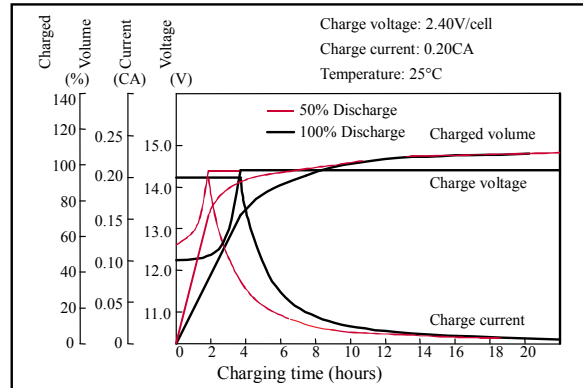

● Temperature effects on capacity

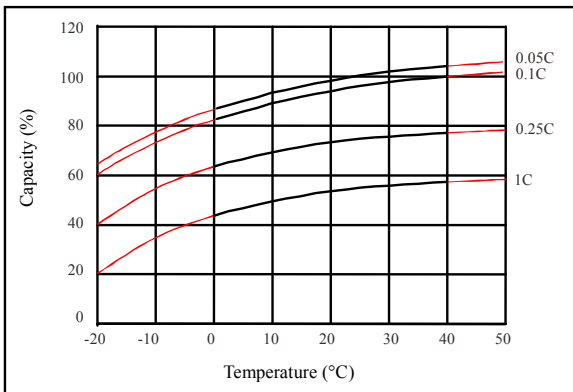

● Self-discharge characteristics

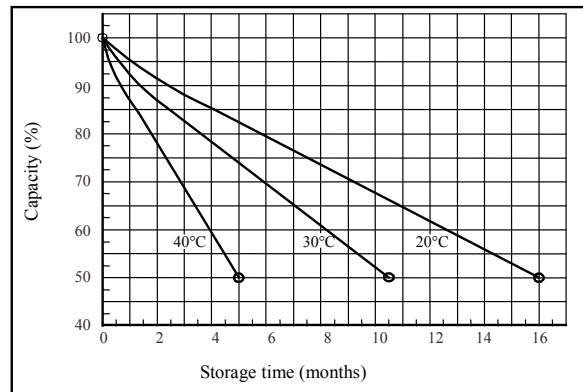

● Floating life on temperature

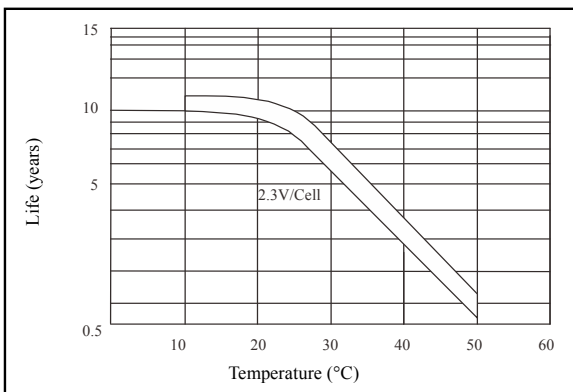

● Cycle life on D.O.D (25°C)

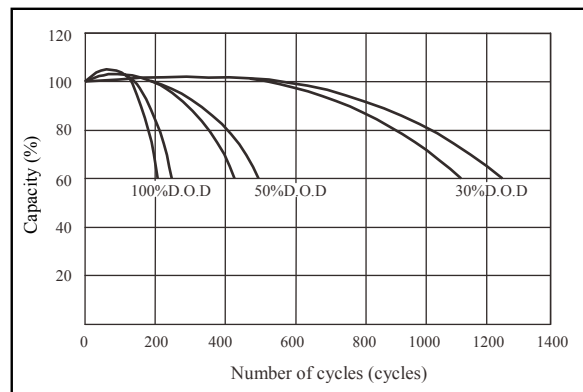

● Relationship for OCV and capacity (25°C)

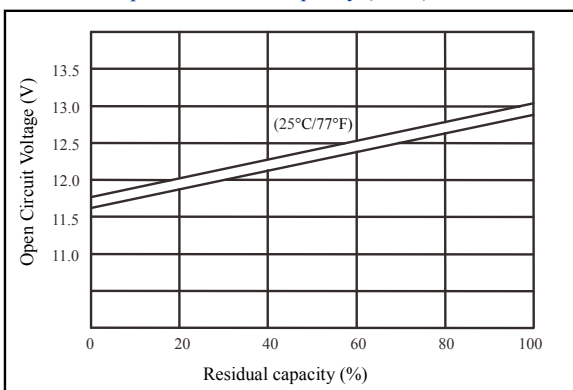

● Relationship for charging voltage and temperature

