

## NP12-2Ah 12V2Ah

### Valve Regulated Lead Acid Battery



#### Specifications

Nominal voltage	12V (6 cells per unit)	
Rated capacity (20HR)	2Ah/10.5V	
Dimensions	Length	70±1mm (2.76inch)
	Width	47±1mm (1.85inch)
	Height	98±1mm (3.86inch)
	Total height	103±1mm (4.06inch)
Approx. weight	0.74kg (1.63lbs)±5%	

#### Outer dimensions (mm)

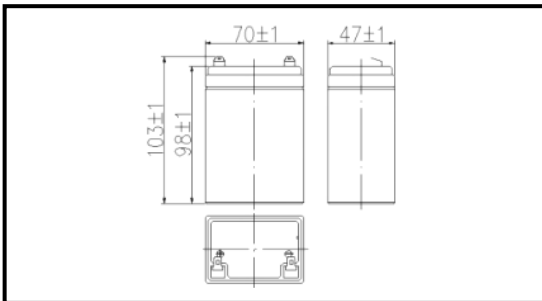

#### Terminal type (mm)

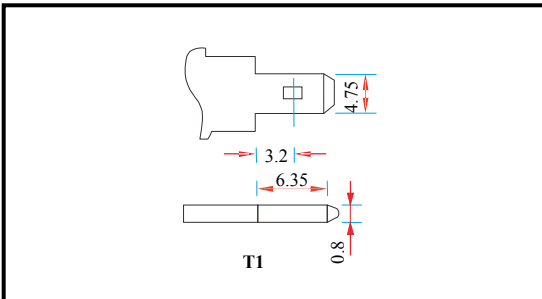

#### Characteristics

Capacity (25°C)	20HR (10.5V)	2.0Ah
	10HR (10.5V)	1.9Ah
	1HR (9.60V)	1.2Ah
Terminal type		T1
Internal resistance (Fully charged, 25°C)		Approx. 72mΩ
Capacity affected by temperature (10HR)	40°C	102%
	25°C	100%
	0°C	85%
	-15°C	65%
Self-discharge (25°C)	3 months	Remaining capacity: 91%
	6 months	Remaining capacity: 82%
	12 months	Remaining capacity: 65%
Nominal operating temperature		25°C±3°C (77°F±5°F)
Operating temperature range	Discharge	-15°C~50°C (5°F~122°F)
	Charge	-10°C~50°C (14°F~122°F)
	Storage	-20°C~50°C (-4°F~122°F)
Float charging voltage (25°C)		13.60 to 13.80V Temperature compensation: -18mV/°C/Block
Cyclic charging voltage (25°C)		14.50 to 15.00V Temperature compensation: -30mV/°C/Block
Maximum charging current		0.6A
Maximum discharge current		30A (5 sec.)
Design life	5 years for floating (25°C)	
	Eurobat (20°C): 3-5 years, standard commercial.	

#### Construction

Component	Positive plate	Negative plate	Container	Cover	Separator	Electrolyte	Safety valve	Terminal
Raw material	Lead dioxide	Lead	ABS	ABS	AGM	Sulfuric acid	Rubber	Copper

#### Constant current discharge characteristics unit: Ampere/Block (at 25°C, 77°F)

F.V/Time	5min	10min	15min	30min	60min	2h	3h	4h	5h	10h	20h
9.60V	7.64	4.84	3.78	2.13	1.31	0.72	0.50	0.41	0.35	0.19	0.1
9.90V	7.41	4.69	3.69	2.09	1.29	0.71	0.49	0.41	0.35	0.19	0.1
10.2V	7.11	4.50	3.55	2.02	1.26	0.71	0.49	0.40	0.34	0.19	0.1
10.5V	6.80	4.31	3.43	1.97	1.23	0.70	0.49	0.40	0.34	0.19	0.1
10.8V	6.42	4.07	3.25	1.90	1.19	0.68	0.47	0.39	0.33	0.18	0.1

#### Constant power discharge characteristics unit: Watt/Block (at 25°C, 77°F)

F.V/Time	5min	10min	15min	30min	60min	2h	3h	4h	5h	10h	20h
9.60V	85.3	54.6	43.1	24.4	15.2	8.38	5.89	4.88	4.17	2.27	1.22
9.90V	82.7	53.0	42.1	23.9	14.9	8.33	5.85	4.85	4.14	2.26	1.21
10.2V	79.3	50.8	40.5	23.2	14.6	8.26	5.81	4.82	4.11	2.25	1.21
10.5V	75.9	48.6	39.1	22.6	14.3	8.14	5.77	4.79	4.08	2.24	1.20
10.8V	71.6	45.9	37.1	21.8	13.8	7.93	5.60	4.64	3.96	2.19	1.18

Note 1: Above characteristics data can be obtained within three charge and discharge cycles.

### ● Discharge characteristics (25°C)



### ● Charging characteristics (25°C)

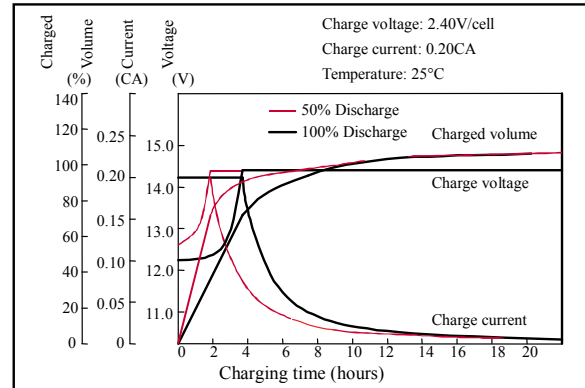

### ● Temperature effects on capacity

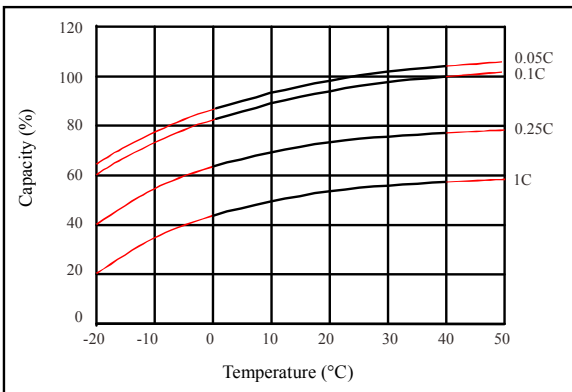

### ● Self-discharge characteristics

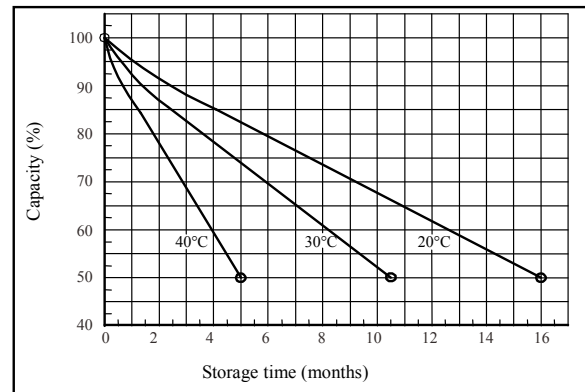

### ● Floating life on temperature

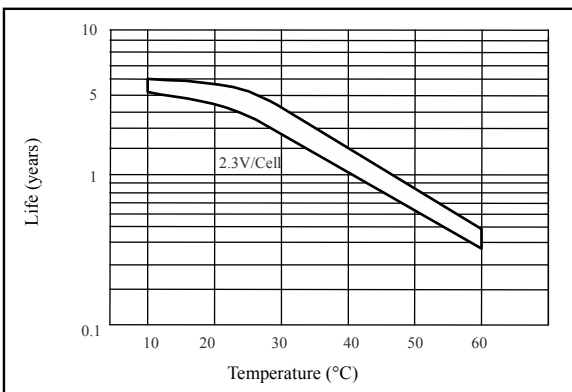

### ● Cycle life on D.O.D (25°C)

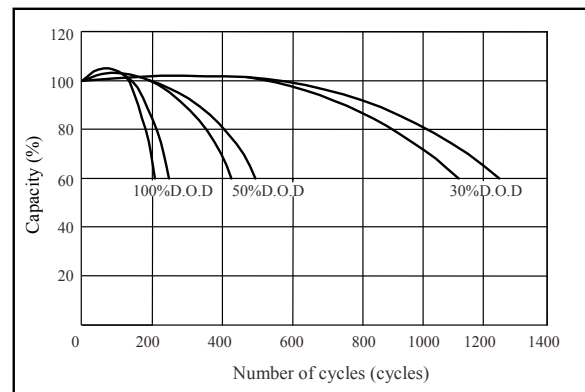

### ● Relationship for OCV and capacity (25°C)

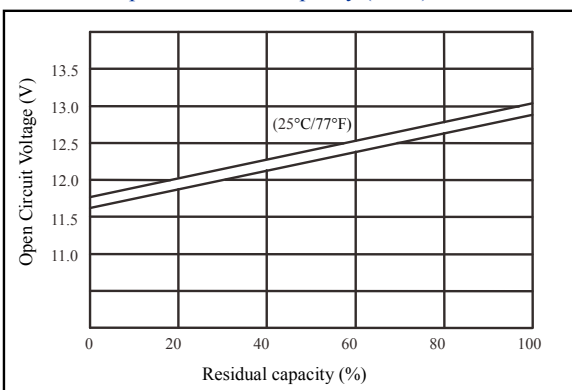

### ● Relationship for charging voltage and temperature

