

## NP12-200Ah 12V200Ah

### Valve Regulated Lead Acid Battery



#### Specifications

Nominal voltage	12V (6 cells per unit)	
Rated capacity (10HR)	200Ah/10.8V	
Dimensions	Length	522±2mm (20.55inch)
	Width	238±2mm (9.37inch)
	Height	218±2mm (8.58inch)
	Total height	222±2mm (8.74inch)
Approx. weight	59.50kg (131.20lbs)±3%	

#### Outer dimensions (mm)

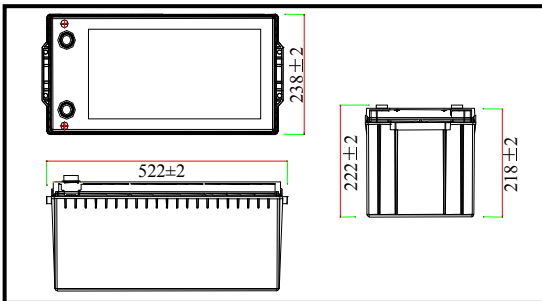

#### Terminal type (mm)

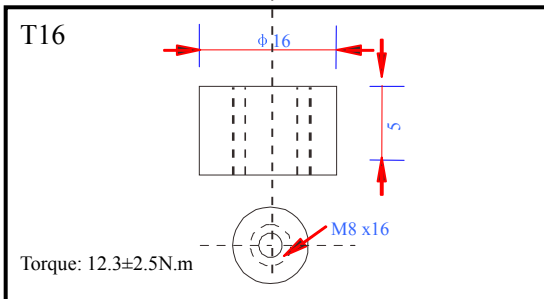

#### Characteristics

Capacity (25°C)	10HR (10.8V)	200Ah
	3HR (10.8V)	150Ah
	1HR (10.5V)	110Ah
Terminal type		T16
Internal resistance (Fully charged, 25°C)		Approx. 3.5mΩ
Capacity affected by temperature (10HR)	40°C	102%
	25°C	100%
	0°C	85%
	-15°C	65%
Self-discharge (25°C)	3 months	Remaining capacity: 91%
	6 months	Remaining capacity: 82%
	12 months	Remaining capacity: 65%
Nominal operating temperature		25°C±3°C (77°F±5°F)
Operating temperature range	Discharge	-15°C~50°C (5°F~122°F)
	Charge	-10°C~50°C (14°F~122°F)
	Storage	-20°C~50°C (-4°F~122°F)
Float charging voltage (25°C)		13.50 to 13.80V Temperature compensation: -18mV/°C/Block
Cyclic charging voltage (25°C)		14.50 to 15.00V Temperature compensation: -30mV/°C/Block
Maximum charging current		60A
Maximum discharge current		1400A (5 sec.)
Design life	10 years for floating (25°C)	
	Eurobat (20°C): 10-12 years, long life.	

#### Construction

Component	Positive plate	Negative plate	Container	Cover	Separator	Electrolyte	Safety valve	Terminal
Raw material	Lead dioxide	Lead	ABS	ABS	AGM	Sulfuric acid	Rubber	Copper

#### Constant current discharge characteristics unit: Ampere/Block (at 25°C, 77°F)

F.V/Time	15min	30min	60min	2h	3h	4h	5h	6h	8h	10h	20h
9.60V	336	201	124	73.1	52.6	42.0	35.9	31.2	24.7	20.4	10.8
9.90V	328	197	122	72.6	52.3	41.8	35.7	31.0	24.5	20.3	10.8
10.2V	316	191	119	72.0	52.0	41.5	35.4	30.8	24.4	20.3	10.7
10.5V	305	186	115	70.9	51.6	41.2	35.2	30.6	24.2	20.1	10.7
10.8V	289	179	111	69.1	50.1	40.0	34.1	29.7	23.5	20.0	10.6

#### Constant power discharge characteristics unit: Watt/Block (at 25°C, 77°F)

F.V/Time	15min	30min	60min	2h	3h	4h	5h	6h	8h	10h	20h
9.60V	3689	2255	1409	846	619	494	424	369	293	243	129
9.90V	3601	2210	1388	841	615	491	422	367	292	243	129
10.2V	3468	2142	1353	834	611	488	419	364	290	242	129
10.5V	3350	2091	1310	821	607	485	416	362	287	240	128
10.8V	3173	2014	1268	800	589	470	404	351	279	239	127

Note 1: Above characteristics data can be obtained within three charge and discharge cycles.

### ● Discharge characteristics (25°C)

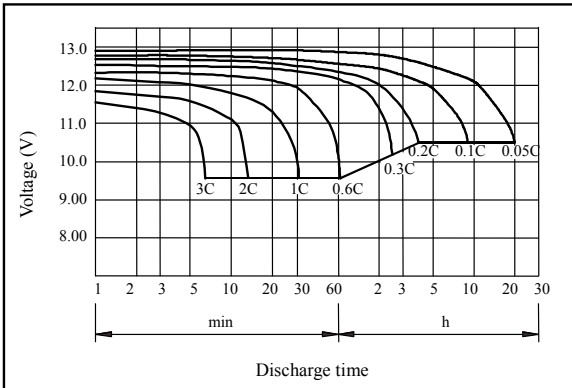

### ● Charging characteristics (25°C)

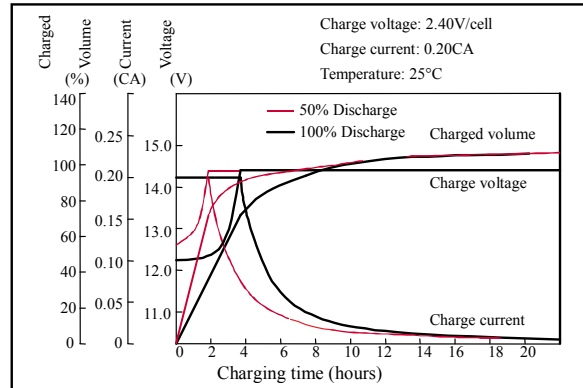

### ● Temperature effects on capacity

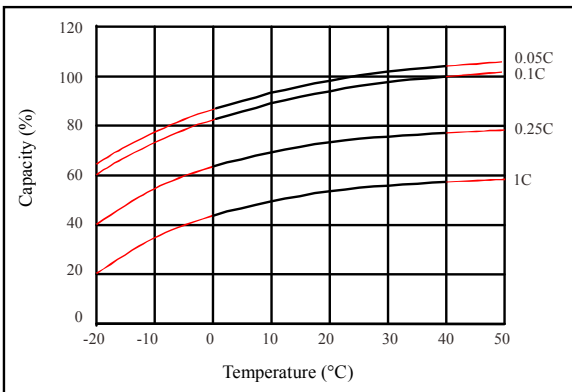

### ● Self-discharge characteristics

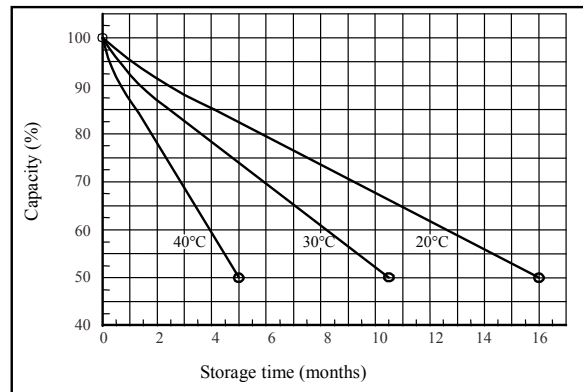

### ● Floating life on temperature

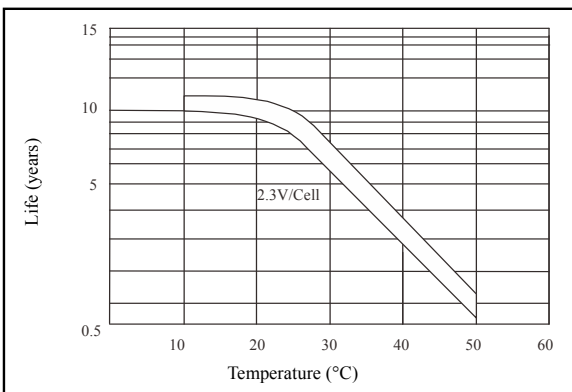

### ● Cycle life on D.O.D (25°C)

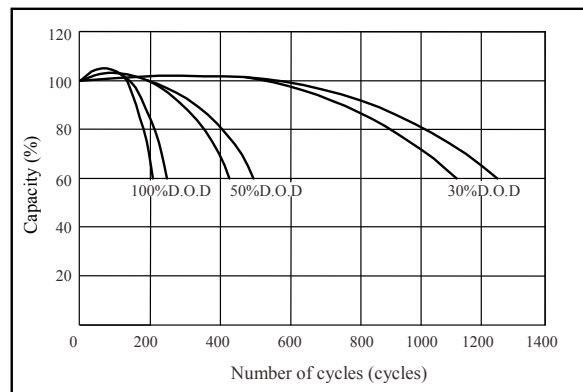

### ● Relationship for OCV and capacity (25°C)

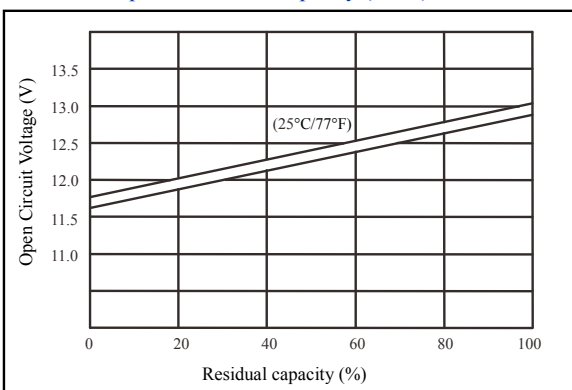

### ● Relationship for charging voltage and temperature

