

FT12-180Ah 12V180Ah

Valve Regulated Lead Acid Battery



Specifications

Nominal voltage	12V (6 cells per unit)	
Rated capacity (10HR)	180Ah/10.8V	
Dimensions	Length	546±2mm (21.50inch)
	Width	125±2mm (4.92inch)
	Height	315±2mm (12.40inch)
	Total height	315±2mm (12.40inch)
Approx. weight	55.00kg (121.20lbs)±3%	

Outer dimensions (mm)

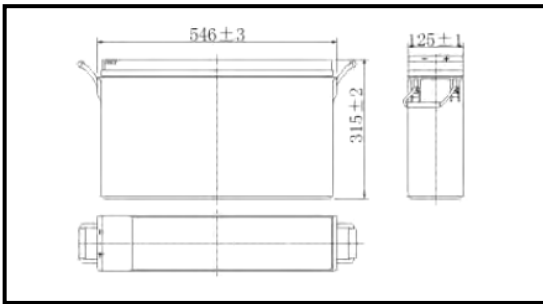

Terminal type (mm)

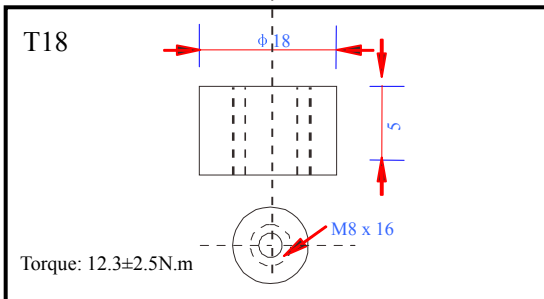

Characteristics

Capacity (25°C)	10HR (10.8V)	180Ah
	3HR (10.8V)	135Ah
	1HR (10.5V)	100Ah
Terminal type		T18
Internal resistance (Fully charged, 25°C)		Approx. 3.5mΩ
Capacity affected by temperature (10HR)	40°C	102%
	25°C	100%
	0°C	85%
	-15°C	65%
Self-discharge (25°C)	3 months	Remaining capacity: 91%
	6 months	Remaining capacity: 82%
	12 months	Remaining capacity: 65%
Nominal operating temperature		25°C ± 3°C (77°F ± 5°F)
Operating temperature range	Discharge	-15°C ~ 50°C (5°F ~ 122°F)
	Charge	-10°C ~ 50°C (14°F ~ 122°F)
	Storage	-20°C ~ 50°C (-4°F ~ 122°F)
Float charging voltage (25°C)		13.50 to 13.80V Temperature compensation: -18mV/°C/Block
Cyclic charging voltage (25°C)		14.50 to 15.00V Temperature compensation: -30mV/°C/Block
Maximum charging current		54A
Maximum discharge current		1300A (5 sec.)
Design life	12 years for floating (25°C)	
	Eurobat (20°C): 10-12 years, long life.	

Construction

Component	Positive plate	Negative plate	Container	Cover	Separator	Electrolyte	Safety valve	Terminal
Raw material	Lead dioxide	Lead	ABS	ABS	AGM	Sulfuric acid	Rubber	Copper

Constant current discharge characteristics unit: Ampere/Block (at 25°C, 77°F)

F.V/Time	15min	30min	60min	2h	3h	4h	5h	6h	8h	10h	20h
9.60V	296	177	109	65.8	47.4	37.8	32.3	28.1	22.2	18.3	9.71
9.90V	289	174	107	65.4	47.1	37.6	32.1	27.9	22.1	18.3	9.69
10.2V	279	168	105	64.8	46.8	37.3	31.9	27.7	21.9	18.2	9.66
10.5V	269	164	101	63.8	46.4	37.1	31.7	27.5	21.8	18.1	9.61
10.8V	255	158	98.1	62.2	45.0	36.0	30.7	26.7	21.1	18.0	9.54

Constant power discharge characteristics unit: Watt/Block (at 25°C, 77°F)

F.V/Time	15min	30min	60min	2h	3h	4h	5h	6h	8h	10h	20h
9.60V	3254	1989	1243	762	557	445	382	332	264	219	117
9.90V	3176	1949	1224	757	554	442	380	330	262	218	116
10.2V	3059	1890	1193	750	550	439	377	328	261	218	116
10.5V	2955	1844	1156	739	546	436	374	326	259	216	115
10.8V	2798	1776	1118	720	530	423	363	316	251	215	114

Note 1: Above characteristics data can be obtained within three charge and discharge cycles.

● Discharge characteristics (25°C)

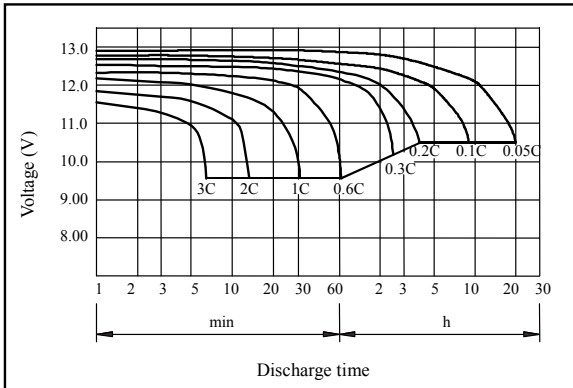

● Charging characteristics (25°C)



● Temperature effects on capacity

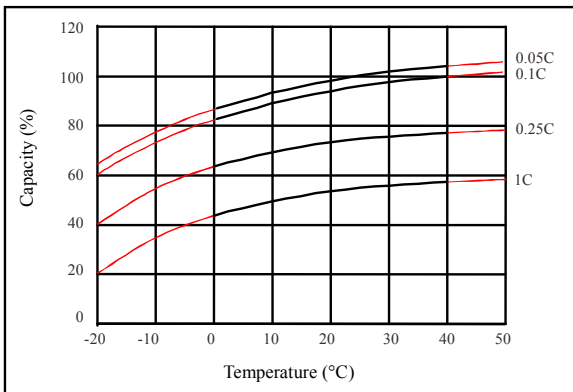

● Self-discharge characteristics



● Floating life on temperature

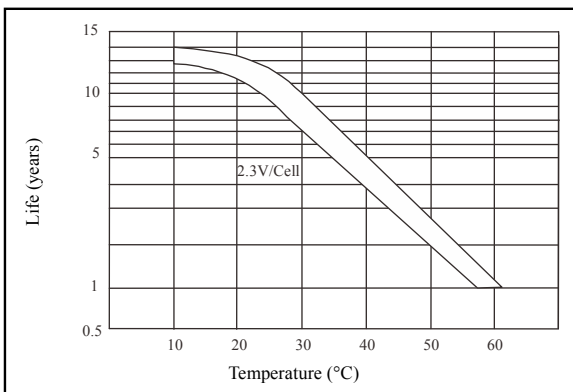

● Cycle life on D.O.D (25°C)

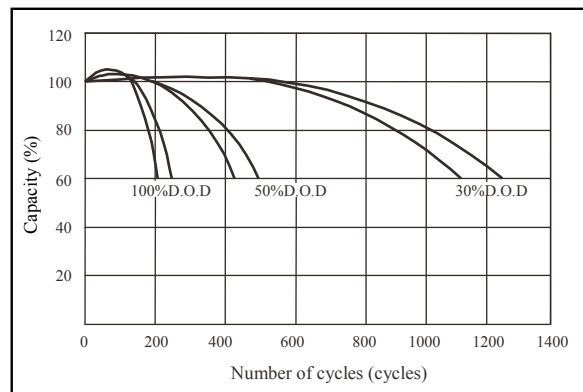

● Relationship for OCV and capacity (25°C)

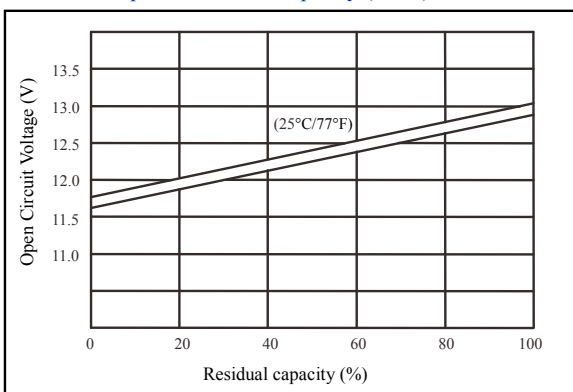

● Relationship for charging voltage and temperature

